



# Russell Hobbs

## Slimline Dishwasher

## Instruction Manual



**Model number: RHSLDW1 (B) (S) (G)**

For Customer Services & Spare Parts please call **0845 208 8750**  
Opening times: Monday - Friday 8am – 6pm & Saturday 9am – 1pm or visit  
us at **[www.productcareuk.com](http://www.productcareuk.com)**

## Contents

<b>Safety Instructions</b>	.....	<b>3 - 4</b>
<b>Before using the appliance</b>	.....	<b>5 - 7</b>
<b>Installation</b>	.....	<b>8 - 10</b>
<b>How to use</b>	.....	<b>11 - 19</b>
<b>Washing procedure &amp; programme selection</b>	.....	<b>20 - 21</b>
<b>Maintenance</b>	.....	<b>22 - 23</b>
<b>Trouble shooting</b>	.....	<b>24 - 26</b>
<b>Specification</b>	.....	<b>27</b>
<b>Connections to mains supply</b>	.....	<b>28</b>
<b>Spare parts</b>	.....	<b>29</b>

For Customer Services & Spare Parts please call **0845 208 8750**  
Opening times: Monday - Friday 8am – 6pm & Saturday 9am – 1pm or visit us at  
**[www.productcareuk.com](http://www.productcareuk.com)**

## Safety Instructions

- **Please comply with these instructions. If you do not, any damage resulting from improper, incorrect or negligent use or improper connection or installation is not covered by the manufacturer's guarantee.**
- **Products must be installed in accordance with the manufacturer's safety recommendations.**
- Additions or modifications to the appliance are not permitted.
- Do not place or store flammable liquids, highly inflammable materials or fusible objects on or near the appliance.
- Small children must be kept away from the appliance.
- The electrical safety of this dishwasher is guaranteed only if it is connected to a properly earthed system, which complies with the electrical safety standards.
- Do not put pressure on the power supply cable while fitting the hob.
- Power supply cable length should not exceed 2m for isolation safety.
- Repairs to the appliance must only be carried out by authorised service personal.
- Make sure all the packaging has been removed before you use the appliance.
- This appliance is not intended for use by persons (including children) with reduced physical, sensory or mental capabilities, or lack of experience and knowledge, unless they have been given supervision or instruction concerning use of the appliance by a person responsible for their safety.
- Children should be supervised to ensure that they do not play with the appliance.
- If the supply cord is damaged, it must be replaced by the manufacturer, its service agent or similarly qualified persons in order to avoid a hazard.
- The appliance is not intended to be operated by means of an external timer or separate remote-control system.
- Do not allow cigarette ashes, candle remains, polish, chemical substances to enter the dishwasher.
- Cutlery with bone, ivory or nacre coated handles, glued items or items soiled with abrasive chemicals.
- Plastic items that are not heat resistant.
- Aluminium and silver objects – these may discolour.
- Some delicate glass types, porcelains with printed patterns as they fade even after the first wash.
- Crystal items should not be put in the dishwasher as these will lose transparency over time.

For Customer Services & Spare Parts please call **0845 208 8750**

Opening times: Monday - Friday 8am – 6pm & Saturday 9am – 1pm or visit us at

**[www.productcareuk.com](http://www.productcareuk.com)**

## Safety Instructions

- Adhered cutlery that is not heat resistant.
- Lead crystal glasses.
- Cutting boards.
- Items manufactured with synthetic fibre.
- Absorbent items such as sponges and kitchen cloths.

### **EC declaration of conformity**

- All stages related to the machine are executed in accordance with the safety rules provided in all relevant directive of the European Community.
- 2004/108/EC, 2006/95/EC, IEC 436/DIN 44990, EN50242

For Customer Services & Spare Parts please call **0845 208 8750**  
Opening times: Monday - Friday 8am – 6pm & Saturday 9am – 1pm or visit us at  
**[www.productcareuk.com](http://www.productcareuk.com)**

## Before using the appliance

- **Products must be installed in accordance with the manufacturer's safety recommendations.**
- **This appliance must only be used for its intended purpose, domestic dishwashing. Any other form of usage is to be considered as inappropriate, dangerous and will void the manufacturer's guarantee**
- **The manufacturer declines all responsibility in the event of damage caused by improper or incorrect use or installation of the appliance.**
- **Before installation, check that all parts listed below are present. If any parts are missing, please contact the product care service team on 0845 208 8750.**

Upper basket	Lower basket	Cutlery basket
Instruction Manual	Water inlet hose	Drainage hose (attached to the back of the machine)

For Customer Services & Spare Parts please call **0845 208 8750**  
Opening times: Monday - Friday 8am – 6pm & Saturday 9am – 1pm or visit us at  
**[www.productcareuk.com](http://www.productcareuk.com)**

## Before using the appliance

### Note

The drawings in the book may vary from your dishwasher model. They are designed to show the different features of all models covered by this book. Your model may not include all features.

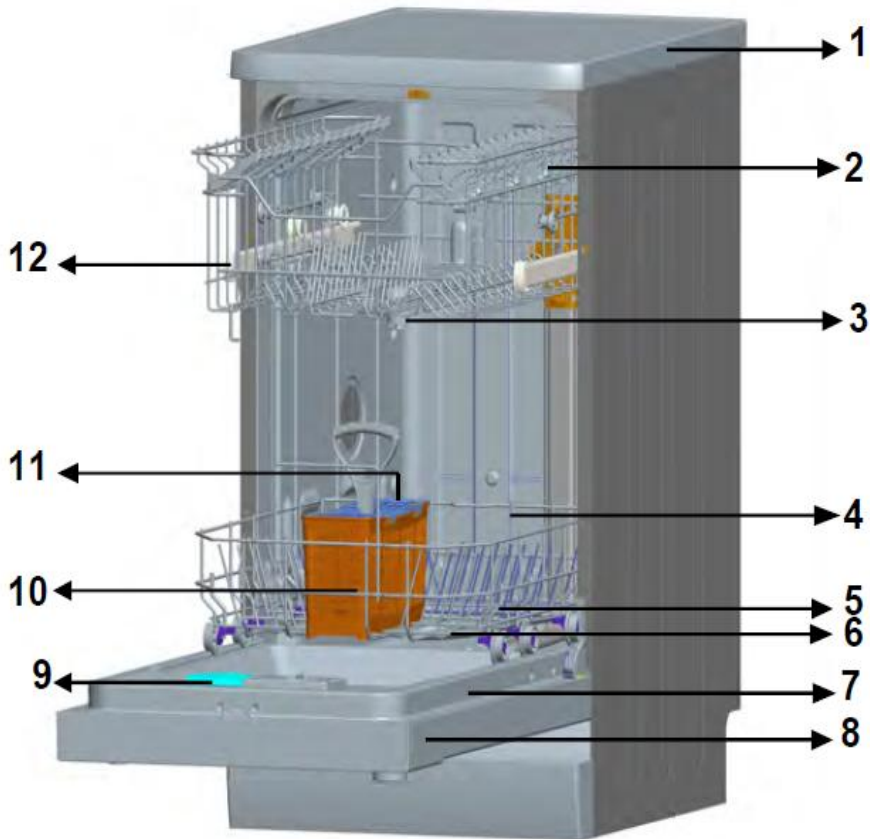

- |                    |                                      |
|--------------------|--------------------------------------|
| 1. Worktop         | 7. Rating Plate                      |
| 2. Upper Basket    | 8. Control Panel                     |
| 3. Upper Spray Arm | 9. Detergent and rinse aid dispenser |
| 4. Lower Basket    | 10. Cutlery Basket                   |
| 5. Lower Spray Arm | 11. Salt Dispenser                   |
| 6. Filters         | 12. Upper Basket Track Latch         |

For Customer Services & Spare Parts please call **0845 208 8750**  
Opening times: Monday - Friday 8am – 6pm & Saturday 9am – 1pm or visit us at  
**[www.productcareuk.com](http://www.productcareuk.com)**

## Before using the appliance

### Control Panel

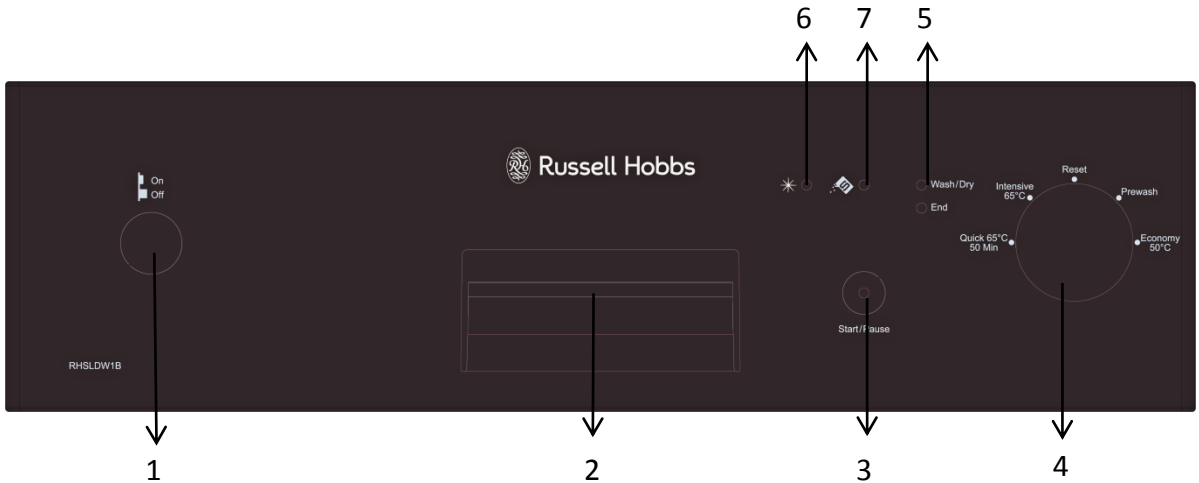

1. Power On/Off button- when the power On/Off button is pressed, the light on the Start/Pause button will illuminate
2. Door handle - used to open/close the door
3. Start/Pause button - once you press the Start/Pause button, the programme you have selected with the programme dial will start running and the indicator lamp 'Wash/Dry' will illuminate. If the programme is paused, the LED light will flash repeatedly.
4. Programme dial - with the programme dial, you can select your desired programme by turning clockwise and anti-clockwise.
5. Status indicator - You can monitor the current status of your programme by using the indicator light shown above. There are two progression states, 'Wash/Dry' and 'End'.
6. Rinse aid indicator – if the low rinse aid indicator light is illuminated, ensure to replenish the rinse aid supply in your dishwasher.
7. Low salt indicator - if the low salt indicator light is illuminated, ensure to replenish the salt supply in your dishwasher.

## Installation

- **Products must be installed in accordance with the manufacturer's safety recommendations. Failure to do so will void the manufacturer's guarantee.**
- Before connecting your appliance to the mains at home, make sure to check the conformity of the voltage settings. These are specified on the information sticker attached to the appliance and/or packaging, with the usage conditions.
- The laws, ordinances, directives and standards in force in the country of use are to be followed (safety regulations, proper recycling in accordance with the regulations, etc.)

### When installing your machine

- After removing the packaging material from the appliance and its accessories, ensure that the dishwasher is not damaged. If you suspect any damage, do not use the appliance and contact an authorised service personal, qualified electrician or Product Care, **(0845 208 8750)**, immediately.
- Ensure you choose a suitable, safe and level place to install your machine.
- We recommend this machine be installed by a qualified engineer.
- Only original spare parts should be used with this machine.
- Before installing, ensure the machine is unplugged.
- All electrical values must match the values indicated on the rating plate.
- Ensure the machine does not stand on the electricity supply cable.
- Never use an extension cable or multiple power point cable when using the appliance.

### Note

**Before using the machine, run a full cycle with the machine empty**

### Location of the Dishwasher

- When determining the place to put your machine, ensure there is sufficient room to fully open the dishwasher door.
- Do not install the machine where the room temperature is likely to drop below 0°C.
- Before positioning, remove the machine from its packaging taking care to follow warning instructions attached.
- Position the machine close to a water tap or drain.
- When moving the machine ensure you do not grip the door or panel.
- Ensure there is sufficient room around the machine to allow it to be moved for cleaning purposes.
- Ensure that the water inlet hose does not become compressed while positioning the machine. Also, make sure that the machine does not stand on the electrical cable.
- Ensure the machine is level when placed on the floor. Adjust the feet by turning them clockwise to raise the height of the machine, and anti-clockwise to reduce the height of the machine. Failure to ensure the machine is level may result in the door not closing properly and the machine to sway (this is not recommended and will void the guarantee).



# Installation

## Water Connection

Ensure the machine is connected to a clean, cold running water supply.

## Water inlet hose



Only use the water inlet hose supplied with this machine. Do not re-use old inlet hoses. Connect the water inlet hose directly to the water inlet tap. The pressure supplied by the tap should be a minimum of 0.03Mpa and a maximum of 1Mpa. If the water pressure is above 1Mpa, a pressure release valve should be fitted. After the connection is made, the tap should be turned on fully so the fitting is secure and there are no leakages. For the safety and maintenance of your machine, make sure you always turn off the water after using the machine.

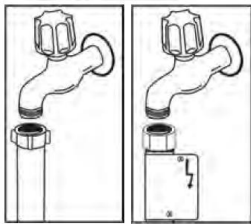

### Note:

Aquastop water spouts are used in some models. If it is there should be no excess tension in it, it is not cut and that it is not twisted.

## Water Outlet Hose

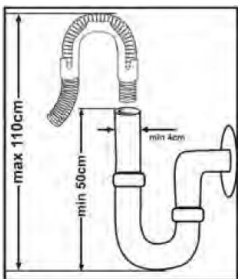

The water drain hose can be connected either directly to the water drain hole or to the sink outlet spigot. Using a special bent pipe, the water can be drained directly into the sink via hooking the pipe over the edge of the sink. This connection should be a minimum of 50cm and at a maximum of 110 cm from the floor.

### Note

If a drain hose longer than 4m is used dishes may remain dirty and manufacturer's guarantee will be void.

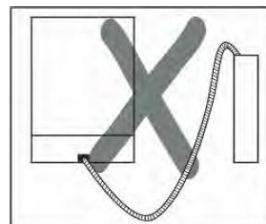
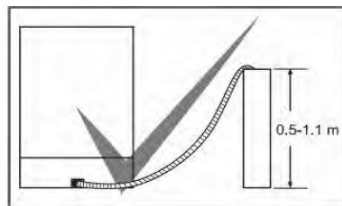

## Installation

### Electrical connection

- **Products must be installed in accordance with the manufacturer's safety recommendations.**
- Before proceeding with the electrical connection, verify that the current carrying capacity of the system and the socket is adequate for the maximum power rating of the dishwasher.
- Electrical installation of the residence and of the appliance's plug must be earthed and conform with the required safety regulations.
- Do not use adaptors, multiple sockets and/or extension leads.
- A circuit breaker with a contact opening of at least 3 mm, rated 20A and delayed functioning type must be installed inside the supply circuit.
- Always use the coated plug supplied with your machine.
- The machine's electric cable should be replaced by a qualified electrician only. Failure to do so may result in injury and will void the manufacturer's guarantee
- Always unplug the machine when a wash cycle has finished. Do not unplug with wet hands. Always ensure you pull the plug, and not the cable leading into the plug.

For Customer Services & Spare Parts please call **0845 208 8750**  
Opening times: Monday - Friday 8am – 6pm & Saturday 9am – 1pm or visit us at  
**[www.productcareuk.com](http://www.productcareuk.com)**

## How to use

### Water

- To maximise cleaning quality, the machine requires soft water, (low calcareous water).
- Lime scale may form on dishes and the interior of the machine in hard water areas. This will reduce the performance of the machine.

### Filling with salt

- **Use softener salt specifically produced for dishwashers – do not use table salt.**
- To insert softener salt, remove the lower basket and open the salt compartment cap by turning it anti clockwise (see image 1).
- Fill the salt compartment by mixing 1kg salt with water (picture 3), for the first time only. For refilling, only insert salt without using water using a funnel to make this easier (see image 4).
- Once this is filled, replace the cap twisting clockwise.
- When the salt indicator light is illuminated, add more salt to the machine.

### Important note

**Immediately after inserting salt, run the machine empty on a short cycle in order to prevent corrosion.**

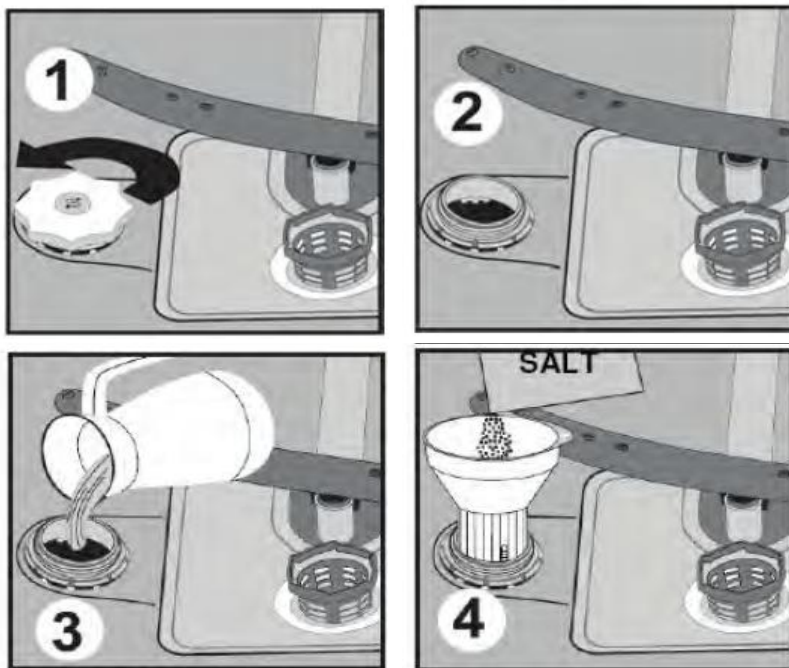

For Customer Services & Spare Parts please call **0845 208 8750**

Opening times: Monday - Friday 8am – 6pm & Saturday 9am – 1pm or visit us at

**[www.productcareuk.com](http://www.productcareuk.com)**

## How to use

### Water softness test

- The washing effectiveness of your machine depends on the softness of the tap water. For this reason, your machine is equipped with a system that reduces the hardness in the mains water supply. To find out the hardness of water in your area, contact your local water board who can determine the hardness of water in your area using a testing strip.
- When you receive a testing strip, dip this into a cup of water for 1 second, remove from the water and shake. Wait for 1 minute and assess the hardness of your water using the below table.

Level												Lime Content
Level 1												No Lime
Level 2											■	Very Low Lime
Level 3										■	■	Low Lime
Level 4						■		■		■	■	Medium Lime
Level 5				■		■		■		■	■	Lime
Level 6		■		■		■		■		■	■	High Lime







For Customer Services & Spare Parts please call **0845 208 8750**  
Opening times: Monday - Friday 8am – 6pm & Saturday 9am – 1pm or visit us at  
**[www.productcareuk.com](http://www.productcareuk.com)**

## How to use

### Adjusting salt consumption

#### Important note

The hardness setting of your dishwasher set to level 3 as a factory default setting

Water Hardness Level	British Hardness dE	Hardness Level Indicator
1	0 - 6	 Wash/Dry Lamp is on End lamp is off Start/Pause Lamp is off
2	7 - 14	 Wash/Dry Lamp is on End lamp is off Start/Pause Lamp is off
3	15 - 21	 Wash/Dry Lamp is on End lamp is off Start/Paus Lamp is off
4	22 - 28	 Wash/Dry Lamp is on End lamp is off Start/Pause Lamp is off
5	29 - 42	 Wash/Dry Lamp is on End lamp is off Start/Pause Lamp is off
6	43 - 63	 Wash/Dry Lamp is on End lamp is off Start/Pause Lamp is off

For Customer Services & Spare Parts please call **0845 208 8750**

Opening times: Monday - Friday 8am – 6pm & Saturday 9am – 1pm or visit us at

[www.productcareuk.com](http://www.productcareuk.com)

## How to use

### Adjusting salt consumption

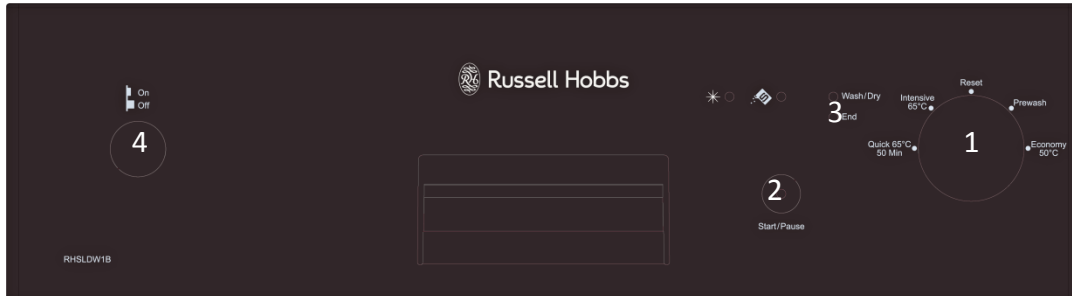

1. Move the programme dial to the Reset position (1) and press the power button to the off position.
2. After switching the programme dial to the Reset position, press the Start/Pause button and hold it down.
3. At the same time that the Start/Pause button is held down, press the On/Off button to switch the machine on (2).
4. Keep Start/Pause button held down until the monitor lights illuminate (2).
5. After lights 'Wash/Dry/End' have flashed (3), release the Start/Pause button (2).
6. Your machine displays the latest entered water setting.
7. You can adjust the levels by pressing the Start/Pause button (2) according to the table of hardness settings above.
8. After adjusting the water hardness level, press the On/Off button (4) to save the settings in memory.

### Detergent Use

Only use a detergent that is specifically designed for domestic dishwashers. Detergent should be put into the compartment located on the inside of the door in prior to starting the machine. Do not overfill the detergent department or this may damage your dishes. For more information regarding the use of detergent, contact the detergent manufacturer.

### Filling the detergent compartment

Push the latch to open the detergent container as shown in image 1. Insert either a dishwasher tablet or powder detergent into the larger of the 2 compartments (b). If you are washing heavily soiled items, pour a small amount (5cm<sup>3</sup>) into the prewash section of the tablet dispenser (a).

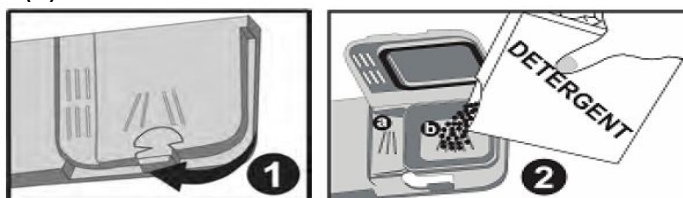

## How to use

### Combined Detergents

Detergent manufacturers also manufacture combined detergents that are called '2 in 1', '3 in 1' and '5 in 1'. This dishwasher is suitable for use of 2 in 1 and 3 in 1 detergents only and must be used on a setting of 65°C or more for them to work effectively.

When using such detergents, always place them into the detergent compartment in the door of the machine and not directly into the interior of the machine. Using these detergents will reduce the need for salt input into your machine as they are made up of a combination of salt and detergent.

Contact the detergent manufacturer if you are not achieving the required standard of cleanliness.

### Rinse aid

- Rinse aid is used to prevent white water drops forming on dishes. To add rinse aid to your machine, remove the rinse aid compartment lid by twisting anti clockwise (1).
- Fill the rinse aid compartment until the rinse aid indicator becomes dark (b). As the rinse aid is used over time, the rinse aid indicator will become lighter (a).
- The rinse aid level adjuster can be set between positions 1 and 6. The higher the number, the more rinse aid will be used. The factory setting for the rinse aid indicator is position 3.

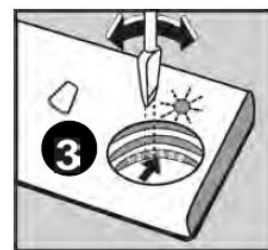
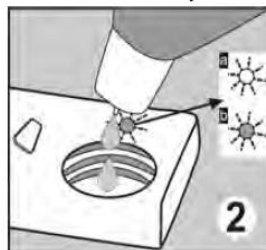

**Please note:** If you can see water stains forming on your dishes you will need to increase the rinse aid level, if you see blue stains on your dishes you will need to decrease the amount of rinse aid used

For Customer Services & Spare Parts please call **0845 208 8750**  
Opening times: Monday - Friday 8am – 6pm & Saturday 9am – 1pm or visit us at  
**[www.productcareuk.com](http://www.productcareuk.com)**

## How to use

### Items not suitable for dishwashing

- Do not allow cigarette ashes, candle remains, polish or chemical substances to enter the dishwasher.
- Cutlery with bone, ivory or nacre coated handles, glued items or items soiled with abrasive chemicals.
- Plastic items that are not heat resistant.
- Aluminium and silver objects – these may discolour.
- Some delicate glass types, porcelains with printed patterns as they fade even after the first wash.
- Crystal items should not be put in the dishwasher as these will lose transparency over time.
- Adhered cutlery that is not heat resistant.
- Lead crystal glasses.
- Cutting boards.
- Items manufactured with synthetic fibre.
- Absorbent items such as sponges and kitchen cloths

### Daily use

- This machine is for domestic use only. Commercial use of the washer will void the manufacturer's guarantee.
- Do not overload the machine. Only place dishwasher safe items in the machine.
- Only use detergents and rinse aids specifically designed for dishwashers. Use of other detergents will void the manufacturer's guarantee.
- Do not drink water out of the machine.
- Do not use chemical dissolving agents such as solvents – this may cause an explosion.
- Check that plastic items are heat resistant before placing them in the machine.
- Do not overfill the machine – this can cause damage.
- Do not open the door while it is in operation. The machine will stop but there is still a risk of burning.
- Do not leave the dishwasher door open. This could lead to injury.
- Always place knives and other sharp object face down in the dishwasher to minimise risk of injury.
- This machine is not designed to be used by children and should only be used by capable individuals.
- Ensure the appliance is only used by persons with sufficient capabilities, experience and knowledge. The instructions in this manual should be followed at all times.



## How to use

### Loading your dishwasher

- Ensure dishes are placed in the machine with sufficient space for water to flow around the dishes. This will allow optimum energy efficiency.
- There are two baskets provided with this machine, the upper basket is designed for cups, glasses, shallow dishes and tea plates. The lower basket is designed for larger plates, cooking pans and dishes.
- For washing cutlery, ensure you use the cutlery basket provided. When washing knives, ensure these are placed point down on in the basket.
- Ensure that you do not balance glasses against each other as these may not remain stable during the wash cycle may break which could result in injury.

### Important note

**Place items in the machine in a way which will not cause the upper spray arms to be obstructed. This will stop the machine functioning correctly.**

### Dish rack(s)

Dish racks are located on the upper basket of the machine. When these are in the open position (a), they can be used for placing cups and long knives on. When in the closed position (b), long glasses can be placed in the upper basket

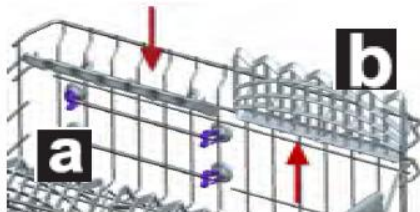

### Top basket height adjustment

The top basket of the machine is adjustable to allow more room in the bottom basket for bigger items. To adjust your basket, open the basket retaining parts at the end of the basket rails by turning them to the sides, then take the basket out. Change the position of the wheels and replace the basket onto the rail. Ensure you close the retainers at the end of the basket hold. This will allow you to raise and lower the basket as desired.

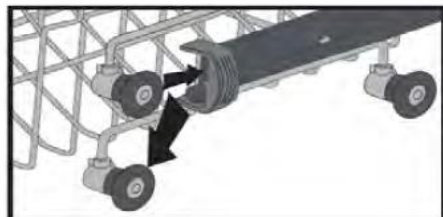

## How to use

### Loading examples

#### Lower basket

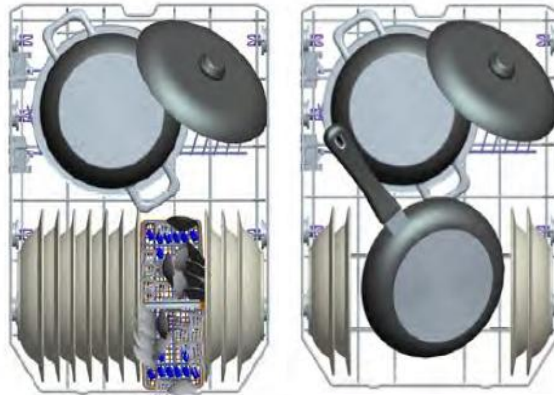

#### Upper basket



#### Incorrect loads

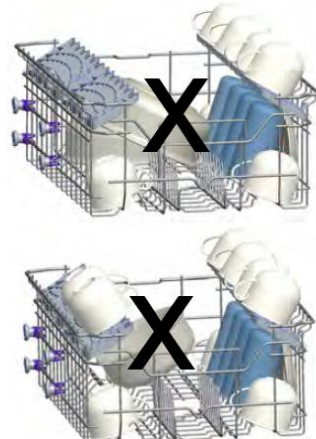
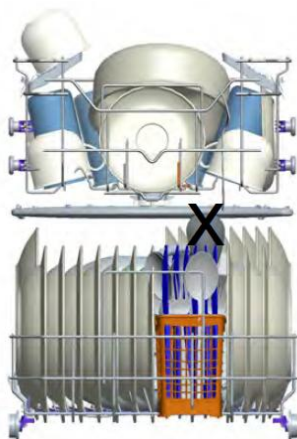

## How to use

### Standard loading

- Upper and lower baskets: 10 place settings (combined/in total).
- The upper basket should be adjusted to the lower position.

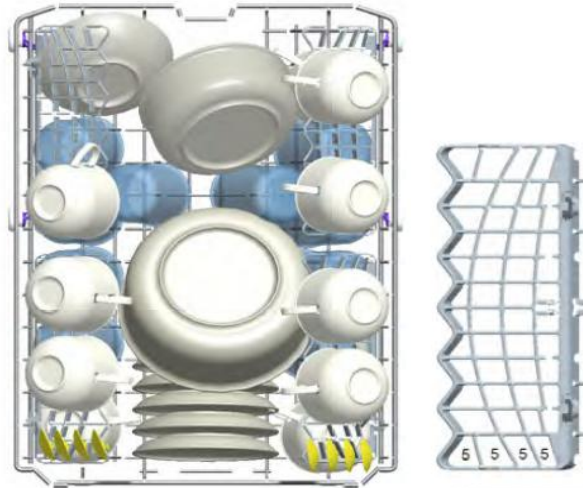

For Customer Services & Spare Parts please call **0845 208 8750**  
Opening times: Monday - Friday 8am – 6pm & Saturday 9am – 1pm or visit  
us at [www.productcareuk.com](http://www.productcareuk.com)

## Washing procedure & programme selection

### Programme items

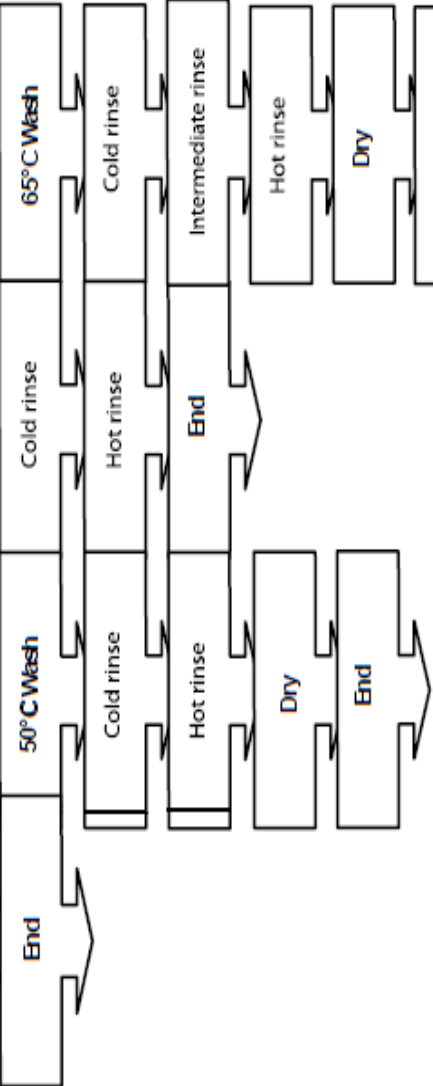
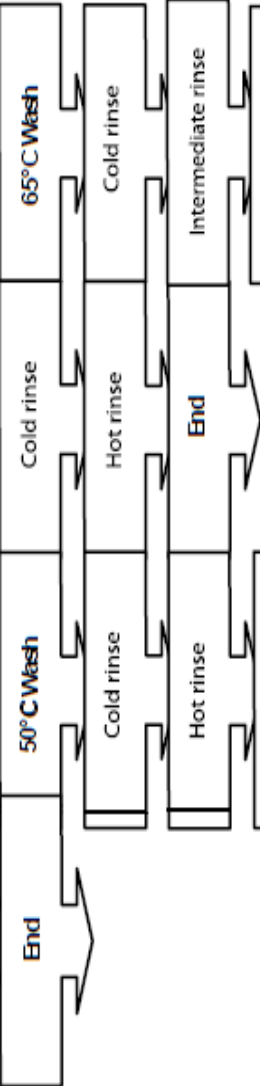
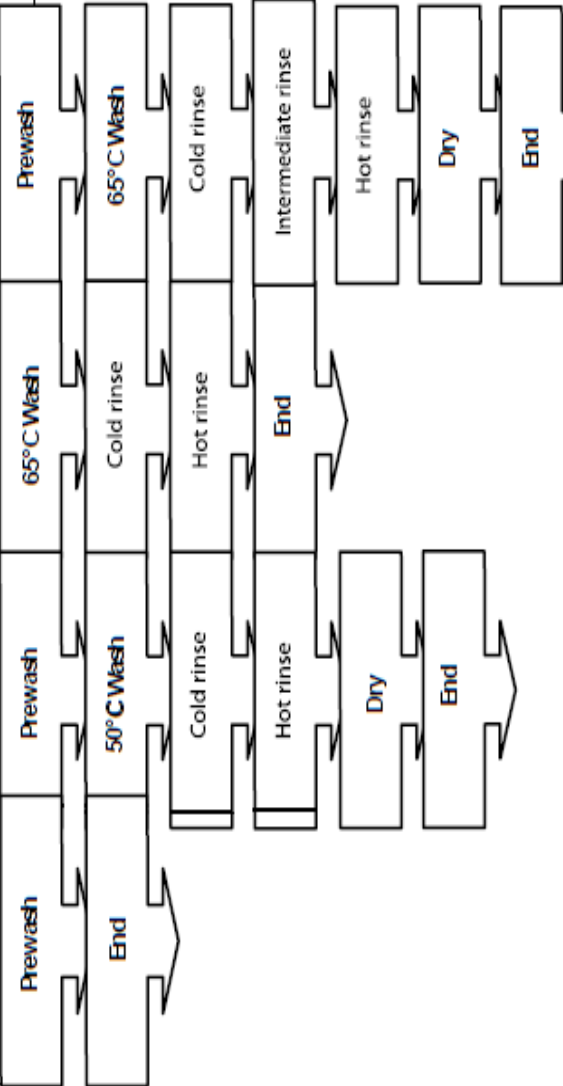
Programme No	Prewash	Economic	Super Wash 50 min.	Intensive
Programme names and temperatures	-	50°C	65°C	65°C
Type of food waste	Pre-wash to rinse and loosen residue awaiting full load- then select a programme	cold meats, vegetables, not kept for long	soups, sauces, pasta, eggs, pilaf, potato and oven dishes, fried foods	soups, sauces, pasta, eggs, pilaf, potato and oven dishes, fried foods
Level of soil	-	medium	medium high	high
Detergent amount A: 25 cm <sup>3</sup> / 15 cm <sup>3</sup> B: 5 cm <sup>3</sup>	-	A+B	A+B	A+B
				
Programme duration (min.)	<b>15</b>	<b>160</b>	<b>50</b>	<b>115</b>
Electricity consumption (KW/hours)	0,02	0,93	1,31	1,45
Water consumption (liters)	3,8	13,6	10,5	17,6

## Washing procedure & programme selection

### Programme selection

#### Switching on the machine

To switch on the machine, press the On/Off button

#### Selecting a programme

To select a programme, turn the programme dial to the desired position.

#### Monitor the wash cycle

You can monitor the progress of the wash cycle by using the programme follow up bulbs. While the programme is running, the top light will illuminate. Once the programme has finished, the bottom light will illuminate.

#### Changing a programme

To reselect a programme during a cycle, press the Play/Pause button once. Wait until the cycle has stopped. This will allow you to reselect a different cycle using the instructions above. The cycle will continue from the point it was stopped at, but will continue as a cycle in the new selected programme.

#### Resetting during a cycle

To reset the machine during a cycle to allow you to reselect a programme from the start, press the Start/Pause button once. Turn the programme dial to the Reset position. Press the Start/Pause button once and wait 30 seconds for the water to be drained from the machine. Once the End light is illuminated, you can reselect a new cycle.

#### Switching the machine off

To switch the machine off after a cycle, wait until the End light is illuminated. Then press the 'On/Off' button.

#### Important note

**If the machine door is opened during a cycle, the power is cut. Once the door is closed, the programme will continue. Users should not open the door during a cycle as this can result in burn injuries.**

**If the power is cut during a cycle, the programme is terminated. The machine will be ready to select a new cycle.**

For Customer Services & Spare Parts please call **0845 208 8750**

Opening times: Monday - Friday 8am – 6pm & Saturday 9am – 1pm or visit us at

**[www.productcareuk.com](http://www.productcareuk.com)**

## Maintenance

Cleaning the machine regularly will prolong the machine's service life.

### Oil and lime accumulation

If oil and lime accumulate in the machine, run a full cycle with the machine empty but with detergent.

### Machine door seal

Use a damp cloth to wipe residues on the door seals regularly. This will prolong the life of the door seal.

### Cleaning the machine

Turn off and unplug the machine before cleaning. Clean the filters and spray arms at least once a month to prevent blockages. Do not use strong detergents when cleaning your machine, wipe with a mild detergent and damp cloth.

### Filters

Check the fine filters for potential food waste deposits. If any food waste is present, remove the filter and rinse thoroughly under a tap: a. Micro Filter, b. Coarse Filter & c. Metal/Plastic filter.

To remove and clean the filter, turn anti-clockwise and take it out by lifting upwards (1).

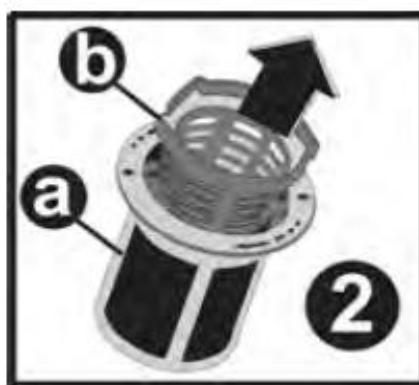

For Customer Services & Spare Parts please call **0845 208 8750**  
Opening times: Monday - Friday 8am – 6pm & Saturday 9am – 1pm or visit  
us at **[www.productcareuk.com](http://www.productcareuk.com)**

## Maintenance

Pull and remove the metal/plastic filter (3). Then pull the coarse filter out of the micro filter (2). Rinse this with water under a tap and refit the metal filter. Insert the coarse filter into the micro filter and line up the corresponding markings. Lock the micro filter into the metal/plastic filter and turn in the direction of the arrow (4) .

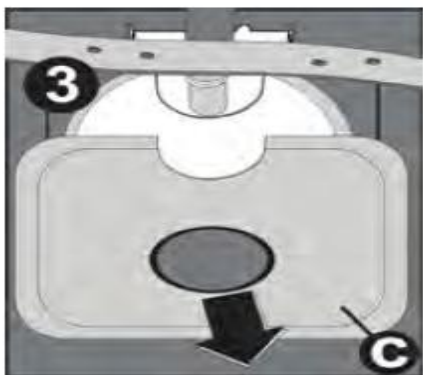

### Important note

**Never use the dishwasher without the filter present. Incorrectly fitting the filter will reduce the washing effectiveness of the machine.**

### Spray arms

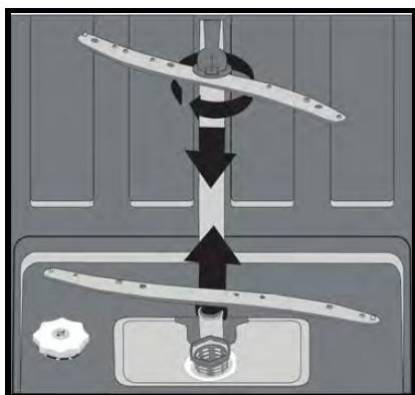

Always check the spray arm water outlet to ensure they are not clogged. If these are clogged, ensure they are cleaned.

The lower spray arm can be removed by pulling it upwards, while the upper spray arm nut can be removed by turning the nut to the left. Ensure the nut is tightened sufficiently when refitting the upper spray arm.











### Hose filter

The inlet hose contains a filter to prevent potential water debris entering the machine. Check the filter hose from time to time and clean if necessary. To clean the filter, first turn the tap off and then remove the hose. After removing the filter from the hose, clean this under the tap. Insert the cleaned filter back into its place inside the hose and refit the hose.



## Trouble shooting

### Error codes

ERROR CODE			ERROR DESCRIPTION	CONTROL
Wash/Dry	End	Start/Pause		
			Inadequate water supply	<ul style="list-style-type: none"> <li>• Make sure the water input tap is totally open and that there is no water cut.</li> <li>• Close the water input tap, separate the water input hose from the tap and clean the filter at the connection end of the hose.</li> <li>• Restart your machine, contact the service if the error resumes.</li> </ul>
			Error of continuous water input	<ul style="list-style-type: none"> <li>• Close the tap.</li> <li>• Contact the service.</li> </ul>
			The waste water in the machine cannot be discharged.	<ul style="list-style-type: none"> <li>• Water discharge hose is clogged.</li> <li>• The filters of your machine might be clogged.</li> <li>• Power off-on your machine and activate the program cancellation command.</li> <li>• If the error continues, contact the service.</li> </ul>
			Intended water temperature could not be reached faulty heater and heater sensor	Contact the service.
			Alarm is active against water overflow	<ul style="list-style-type: none"> <li>• Power off your machine and close the tap.</li> <li>• Contact the service.</li> </ul>
			Faulty electronic card	Contact the service.

### Programme monitor light is on and Start/Pause light is flashing

Your machine door is open. Shut the door.

### The programme won't start

- Check the machine is plugged in.
- Check the indoor fuses in your home's fuse box.
- Ensure the water inlet hose is connected and the valve on the tap is open.
- Ensure the machine door is closed.
- Ensure the machine is switched on.
- Ensure the water inlet filters are not clogged.

For Customer Services & Spare Parts please call **0845 208 8750**

Opening times: Monday - Friday 8am – 6pm & Saturday 9am – 1pm or visit us at **www.productcareuk.com**



## Trouble shooting

### **'Wash/Dry' and 'End' keep flashing**

- Water overflow alarm is active.
- Turn off the tap and contact Product Care on 0845 208 8750 for further advice.

### **Control lamps illuminated after cycle has finished**

The 'On/Off' button has not been released.

### **Detergent residues are left in the detergent compartment**

Detergent has been added when the detergent compartment is wet. Wipe dry the detergent compartment before using the machine again.

### **Water will not drain**

- The water drain hose is clogged or twisted.
- The filters are clogged.
- The programme has not yet finished.

### **The machine stops during cycle**

- Power failure.
- Water inlet failure.
- Programme may be in standby.
- The door has been opened and not closed correctly.

### **Dishwasher is noisy**

- Dishes are placed incorrectly inside the machine.
- The spray arm is hitting the dishes.

### **Dishes are still dirty after washing**

- Dishes are not placed correctly in the machine – spray water is not hitting them.
- Basket is overloaded.
- Not enough detergent is added.
- An unsuitable programme has been selected.
- Spray arm has become clogged.
- Filters are clogged.
- Filters are incorrectly fitted.
- Water drain pump is clogged

## Trouble shooting

### **White stains remain on the dishes after washing**

- Not enough detergent is being used.
- Rinse aid setting is too low.
- Salt is needed due to hard water
- Water softener setting at low level.
- Salt compartment cap not closed properly.

### **Dishes won't dry**

- A programme without a dry operation has been selected.
- Rinse aid dosage set too low.
- Dishes unload before the programme has selected.

### **Rust stains are present on dishes**

- High rate of salt in water.
- Salt compartment cap not closed properly.
- Too much salt spilt on the sides and into the machine while filling with salt.
- Unhealthy mains grounding.

**If you having continuing issues after exploring possible solutions given, please contact Product Care on 0845 208 8750 for further advice.**

For Customer Services & Spare Parts please call **0845 208 8750**  
Opening times: Monday - Friday 8am – 6pm & Saturday 9am – 1pm or visit  
us at **[www.productcareuk.com](http://www.productcareuk.com)**

## Specification

### Specification

Model	RHSLDW1(B) (S) (G)
Dimensions (mm)	(H)845 X (W)450 X (D)598
Capacity	10 place settings
Net weight (Kg)	40
Electricity Input	220 – 240 V , 50Hz
Total Power (W)	1900
Heating Power (W)	1800
Pump Power (W)	100
Drain Power (W)	30
Water Supply Pressure	0,03MPa (0,3 bar) – 1MPa (10)
Current (A)	10

For Customer Services & Spare Parts please call **0845 208 8750**  
Opening times: Monday - Friday 8am – 6pm & Saturday 9am – 1pm or visit  
us at **[www.productcareuk.com](http://www.productcareuk.com)**

## Connection to the mains supply

### **WARNING-** THIS APPLIANCE MUST BE EARTHED

This appliance is designed to operate from a mains supply of AC230V ~ 50HZ.  
Check that the voltage marked on the product corresponds with your supply voltage.

This product is fitted with a 13A plug complying with BS1363.

If this plug is unsuitable or needs to be replaced, please note the following:

Important: The wires in the mains lead are  
Coloured in accordance with the following code:  
GREEN/YELLOW - EARTH  
BLUE - NEUTRAL  
BROWN - LIVE



For UK use only – Plug fitting details (where applicable):

As the colours of the wires in the mains lead of this appliance may not correspond with the coloured markings identifying the terminals in your plug, proceed as follows:

The GREEN/YELLOW wire is the EARTH and must be connected to the terminal which is marked with the letter E or by the earth symbol or coloured GREEN or GREEN/YELLOW.

The BLUE wire is the NEUTRAL and must be connected to the terminal marked with the letter N or coloured BLACK.

The BROWN wire is the LIVE wire and must be connected to the terminal marked with the letter L or coloured RED.

Always ensure that the plug cord grip is fastened correctly.

If a 13A (BS1363) fused plug is used it must be fitted with a 13amp fuse conforming to BS1362 and be BSI or ASTA approved.

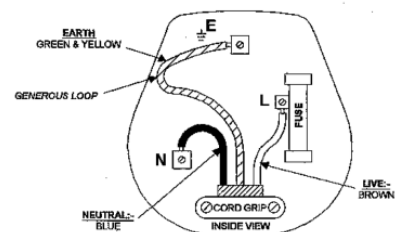

For Customer Services & Spare Parts please call **0845 208 8750**  
Opening times: Monday - Friday 8am – 6pm & Saturday 9am – 1pm or visit  
us at **[www.productcareuk.com](http://www.productcareuk.com)**

## Spare parts

Spare part	Contact details
Upper basket	Available at <a href="http://www.productcareuk.com">www.productcareuk.com</a> or call 0845 208 8750
Lower basket	Available at <a href="http://www.productcareuk.com">www.productcareuk.com</a> or call 0845 208 8750
Cutlery basket	Available at <a href="http://www.productcareuk.com">www.productcareuk.com</a> or call 0845 208 8750
Inlet hose	Available at <a href="http://www.productcareuk.com">www.productcareuk.com</a> or call 0845 208 8750
Other	Available at <a href="http://www.productcareuk.com">www.productcareuk.com</a> or call 0845 208 8750

For Customer Services & Spare Parts please call **0845 208 8750**  
Opening times: Monday - Friday 8am – 6pm & Saturday 9am – 1pm or visit  
us at [www.productcareuk.com](http://www.productcareuk.com)

For Customer Services & Spare Parts  
please call

**0845 208 8750**

Opening times: Monday - Friday  
8am – 6pm & Saturday 9am – 1pm

or visit us at

**www.productcareuk.com**

Revision 1



This symbol is known as the 'Crossed-out wheellie bin Symbol'. When this symbol is marked on a product/batteries, it means that the product/batteries should not be disposed of with your general household waste. Only discard electrical/electronic/battery items in separate collection schemes, which cater for the recovery and recycling of materials contained within. Your co-operation is vital to make sure the success of these schemes and for the protection of the environment. For your nearest disposal facility, visit [www.recycle-more.co.uk](http://www.recycle-more.co.uk) or ask in store for details.

We reserve the right due to possible changes to design to alter the instruction manual without prior notice.

For Customer Services & Spare Parts please call **0845 208 8750**  
Opening times: Monday - Friday 8am – 6pm & Saturday 9am – 1pm or visit  
us at **www.productcareuk.com**